

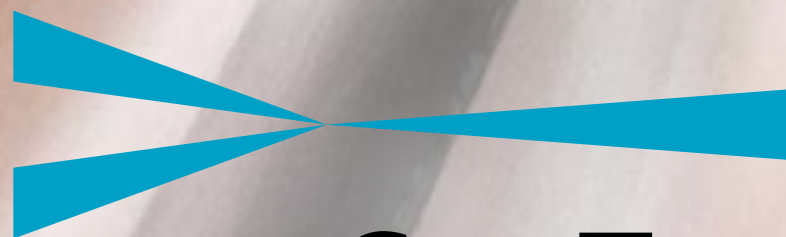

DIRTY JOBS



nuova **ConTec**
NOZZLE CATALOG

At the end of any high pressure cleaning process a **nozzle** is always required.
It takes water from the pump through the pipe and turns it into a work tool.
This tool may be used to unblock an obstructed pipe, to clean a storm drain,
to break down an obstruction, to remove sand or roots....
or it simply helps you doing a good job.

Nuova Contec is aware of the importance that you give to your equipment
and therefore invested years to develop and research the best solutions
for the people who made high pressure a life choice.

Our **mission** is to help our customers make the right choice.

We provide you our **experience, research and development**
and especially our ability to offer **quality products at the right price.**

This catalogue is for operators of the high pressure drain pipe cleaning industry.
The aim of the catalogue is to guide you to the work tools that suit your needs.

The catalogue is very easy to consult and dynamic.

We added QR codes for direct connection with your smartphone or tablet;
you can watch demo videos to visualize the actual functionality of our nozzles.

Try it out now! The QR code below will connect you directly
to the **Nuova Contec channel.**

Make your choice and enjoy your work!



DISCLAIMER

All rights reserved.

The material in this catalog: images, texts, tables, icons, etc., is exclusive property of Nuova Contec Srl.
It's forbidden to use any part of it, including storage, reproduction, reprocessing, diffusion or distribution
by any technological platform, support or telematic network (including social networks –
e.g. Facebook®, Twitter®, etc...) without the express written permission of Nuova Contec Srl.

Nuova Contec reserves the right to change the characteristics of its products at any time.
The products and the accessories provided may not be identical to those shown in the photos.

Updated data sheets are available on our website for each nozzle series.

To have videos and photos of our products always at hand, join our channels



<https://t.me/myjobchannel>

<https://t.me/myjobgallery>

and follow our profiles on



<https://www.facebook.com/nuovacontecsrl/>



<https://www.youtube.com/user/Nuovacontec>

CONTENTS

PAG. 4	NOZZLE SELECTION GUIDE
PAG. 6	SEWER CLEANING NOZZLES FARA AND DURANNO CANIN ITALO ISONZO RAUT BORA FANNA LIVENZA ARZINO
PAG. 11	DESANDERS NOZZLES MAGREDI NATISONE STRAIGHT ROTATING SWIVELS
PAG. 13	ROTATING AND VIBRATING NOZZLES TREMOL AVIAN TURBINE GRIS RAVEDIS MALNIS
PAG. 16	ROOT-CUTTERS NOZZLES AVIAN SOLO CARNIA FRIULI MANIAGO ROOT RANGER
PAG. 20	NOZZLE FOR DOMESTIC AND CONDOMINIUM PIPELINES SILE PICIUL MEDUNA RAUT CELLINA VORTEX PIAVE LIVENZA ARZINO TREMOL GRIS BORA CANIN ISONZO
PAG. 23	CENTRALIZERS
PAG. 24	VENTURI PUMP
PAG. 25	SPECIAL NOZZLES - MEDUSA
PAG. 26	SAVE HOSE DEVICES
PAG. 27	MANHOLE COVER LIFTERS

LEGEND

These symbols are adopted in the catalogue to represent the following sizes:

 Weight	 Lower jets	 Inserts
 Front jets	 Upper jets	 DN working
 Rear jets	 Jets of rotation/side	 Nozzle compatible with water recycling systems

Part number (bold) refers to the nozzles in standard version (normally with ceramic inserts).

Same number + **W** refers to **carbide** inserts version.

Example: **65540.600** Fara 1" nozzle w/ceramic inserts - **65540.600W** Fara 1" nozzle w/**carbide** inserts

JETTING TROU

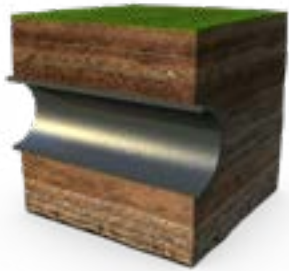

DRAIN AND SEWER
CLEANING NOZZLES



PICIUL



ITALO



FARA



AGGRESSIVE NOZZLES
FOR LIMESTONE REMOVAL



GRIS



TREMOL



RAVEDIS



HEAVY DUTY NOZZLES
FOR SAND AND MUD REMOVAL



PIAVE



CANIN



NATISONE

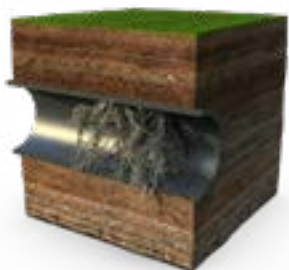

ROOT CUTTING
NOZZLES



ROOT RANGER



AVIAN



SOLO



UNBLOCKING NOZZLES
(GREASE AND OBSTRUCTIONS)



BORA



RAUT



AVIAN TURBINA

BLESHOOTING



DURANNO

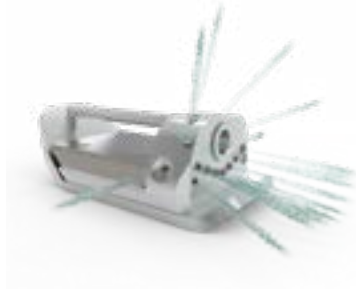

MAGREDI PLUS



RAUT



AVIAN

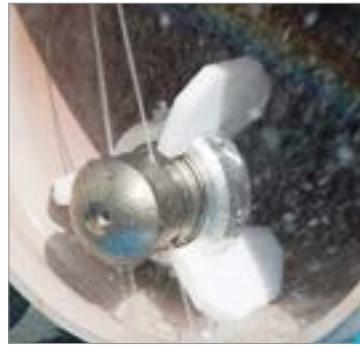

MAGREDI



VENTURI



CARNIA/FRIULI



MANIAGO



LIVENZA



ARZINO





FARA

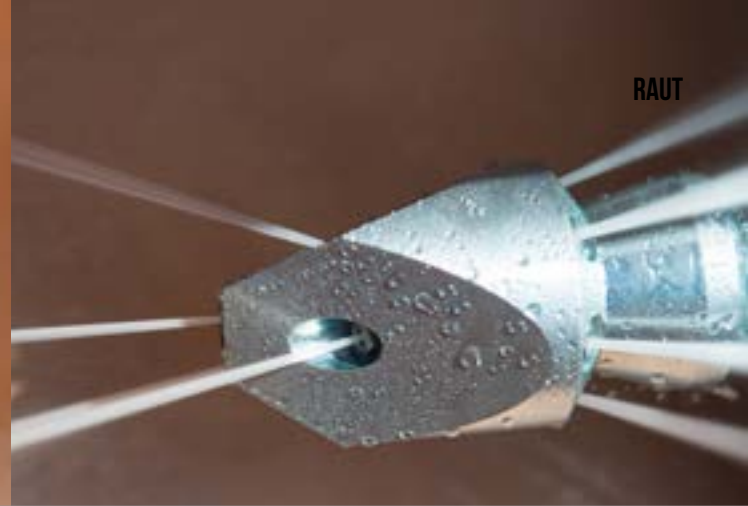

RAUT

SEWER CLEANING NOZZLES

We offer a wide range of nozzles with interchangeable **carbide (W)**, ceramic or steel inserts for sewer cleaning application. These nozzles differ in size, weight, shape (grenade, torpedo triangle ...), number and angle of jets, both rear and front ones.

All nozzles are made by hardened steel, some of them by hardened stainless steel.

Carbide inserts (**W**) are more resistant and durable compared with conventional ones (ceramic or steel). They are strongly recommended with water recycling system.

Advantages:

- higher cleaning efficiency
- less water and fuel consumption
- longer nozzle life and less maintenance costs

FANNA

Round head nozzles for cleaning application

FARA AND DURANNO

Heavy grenade nozzles with interchangeable carbide or ceramic inserts

CANIN

High traction capacity torpedo nozzles with carbide or ceramic interchangeable inserts

ITALO

Stainless steel cleaning nozzles, with carbide inserts

ISONZO

Stainless steel heavy nozzles, torpedo shape, with carbide or ceramic inserts

RAUT

Triangle shaped nozzles with 4 front jets for unblocking application or top-bottom cleaning

BORA

Stainless steel nozzles with high impact front spinning jet for unblocking applications (grease, roots, ice...).

LIVENZA

Conical head nozzles

ARZINO

Egg nozzles

Part number (bold) refers to the nozzles in standard version (normally with ceramic inserts). Same number + **W** refers to **carbide** inserts version.

Example:

65540.600 Fara 1" nozzle w/ceramic inserts

65540.600W Fara 1" nozzle w/**carbide** inserts

FARA AND DURANNO

Highly efficient heavy duty nozzles with ceramic or carbide interchangeable inserts.
Supplied in stainless steel on request



	Fara	Duranno
	1" F	1" F 1 1/4" F
DxL	87 x 140 mm	107 x 180 mm
KG	3.6 kg	7,7 kg
°	10 x 15°	7 x 20° + 7 x 30°
mm	85510.Wxx	85510.Wxx
mm	150-400 mm	300-1000 mm
#	65540.600W	65540.811W 65540.801W

CANIN

Very high traction torpedo nozzles



	1/2" F	3/4" F	1" F	1 1/4" F
DxL	49 x 75 mm	68 x 125 mm	98 x 210 mm	
KG	0,8 kg	2.5 kg	5.6 kg	
°	6 x 10°	3 x 6° + 3 x 12°	5 x 5° + 5 x 10°	
mm	85511.Wxx	85510.Wxx	85510.Wxx	
mm	80-200 mm	100-250 mm	150-400 mm	
#	65540.765W	65540.760W	65540.710W	65540.750W

ITALO

Stainless steel nozzles with interchangeable carbide inserts



	1/2" F	1" F
DxL	44 x 58	69 x 95 mm
KG	0,4 kg	1,6 kg
Angle	8 x 20°	8 x 20°
Material	85511.Wxx	85510.Wxx
Length	70-200 mm	100-400 mm
#	65540.290	65540.300

ISONZO

Grenade nozzles made of hardened stainless steel with ceramic or carbide inserts



	1/2" F	3/4" F	1" F	1" 1/4 F
DxL	49 x 80 mm	69 x 108 mm	90 x 135 mm	
KG	0,8 kg	1,4 kg	4,1 kg	
Angle	6 x 30°	8 x 30°	12 x 30°	
Material	85511.Wxx	85510.Wxx	85510.Wxx	
Length	70-200 mm	80-300 mm	200-700 mm	
#	65540.100W	65540.200W	65540.420W	65540.421W

RAUT

Stainless steel triangle nozzles with 4 front jets and ceramic inserts, also available with carbide inserts (**W**)



	3/4" F	1" F	1" 1/4 F
DxL	50 x 92 mm	59 x 105 mm	78 x 142 mm
KG	0,59 kg	0,94 kg	2,6 kg
Y	6 x 20°	6 x 20°	6 x 20°
Z	3 + 1 x 20°/0°	3 + 1 x 20°/0°	3 + 1 x 20°/0°
Material	85511.(W)xx	85510.(W)xx / 85511.(W)xx	85510.Wxx / 85511.Wxx
Ø	80-300 mm	100-400 mm	150-500 mm
#	5550.20C(W)	5550.30C(W)	5560.40W

BORA

Stainless steel nozzles with ceramic inserts and rotating front jet for a strong impact and a wide contact surface

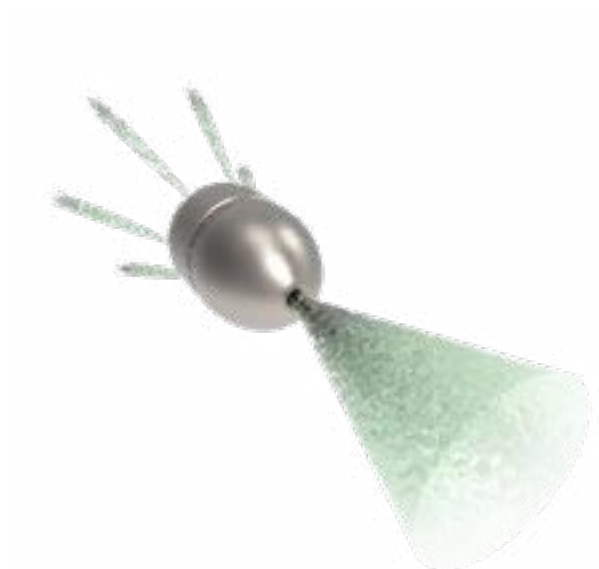

	3/4" F	1" F
DxL	68 x 107 mm	
KG	2,1 kg	
Y	8 x 20°	
Z	1 x 20° rotante	
Material	85510.xx	
Ø	150-350 mm	
#	75210.01	75350.01

FANNA

Round head nozzles for cleaning applications



	3/4" F	1" F
DxDL	49 x 50 mm	58 x 60 mm
KG	0,5 kg	0,73 kg
	6 x 30°	6 x 30°
	1 x 0°	1 x 0°
	85993.xx	85993.xx
	85-250 mm	100-300 mm
#	5516.20C	5516.30C

LIVENZA

Small conical nozzles with M6 interchangeable rear inserts



	3/4" F	1" F
DxDL	49 x 58 mm	58 x 69 mm
KG	336 gr	500 gr
	20°	20°
	1 x 0°	1 x 0°
	85993.xx	85993.xx
	85 - 250 mm	100 - 300 mm
#	5515.600C	5515.700C

ARZINO

High traction nozzles with interchangeable rear inserts



	3/4" F	1" F	1" 1/4 F
DxDL	58 x 72 mm	69 x 85 mm	88 x 120 mm
KG	0,78 kg	1,30 kg	3,25 kg
	8 x 15°	8 x 15°	8 x 20°
	85511.xx	85511.xx	85510.xx
	100-250 mm	120-350 mm	200-500 mm
#	5532.08C	5533.08C	5534.08



DESILTING NOZZLES

NATISONE

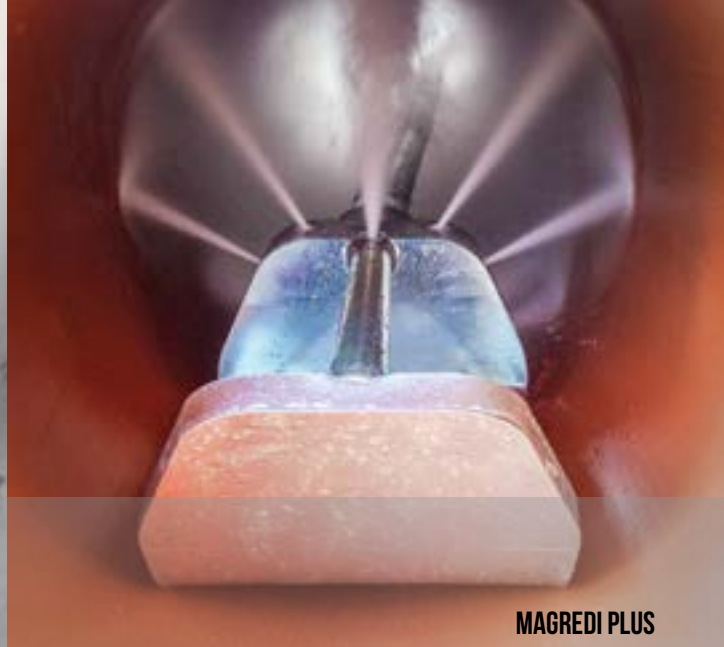

MAGREDI PLUS

The main characteristics of the desanding nozzles are the high weight and the orientation of the jets towards the bottom of the pipe, so as to concentrate all the water flow of the pump in the thrust and simultaneous removal of mud, sand and sediment deposits.

We recommend the use of **rotary swivels** to connect these heavy nozzles to the high pressure hoses.

These nozzles are supplied with interchangeable ceramic or **carbide (W)** inserts. The latter ones are recommended with water recycling systems.

MAGREDI

Sledge nozzle with washing jets having different inclinations for a more effective work in pipes up to DN 1500.

These nozzles can have 2 different configurations depending on the operating requirements:

- **Basic:** sledge desander with 9 jets having differentiated inclinations (0° - 25°) oriented towards the bottom of the pipeline
- **Plus:** washing nozzle with 9 jets oriented towards the bottom and 7 jets at 90° and 75° towards the sides and the top of the pipe for a more direct and incisive cleaning action

Part number (bold) refers to the nozzles in standard version (normally with ceramic inserts). Same number + **W** refers to **carbide** inserts version.

Example:

65500.800 Natisone 3/4" nozzle w/ceramic inserts

65500.800W Natisone 3/4" nozzle w/**carbide** inserts

NATISONE

Self-balancing heavy-duty desanding nozzles with direct water jets towards the bottom of the pipeline for sand and sediments efficient removal.

To be used in circular or ovoid pipelines

STRAIGHT ROTATING SWIVELS



5030.20A
3/4"



5030.25A
1"



5030.32A
1" 1/4"

MAGREDI AND MAGREDI PLUS

Basic configuration with 9 jets for sand and debris removal in flat/big pipes

Plus configuration with 16 jets makes it an all-around cleaning nozzle, more effective than a conventional nozzle: lower part of the pipe is flushed with low inclination jets for an increased traction and removal capacity. Upper side of the pipe is flushed with high inclination jets with increased cleaning efficiency than a conventional nozzle



Basic

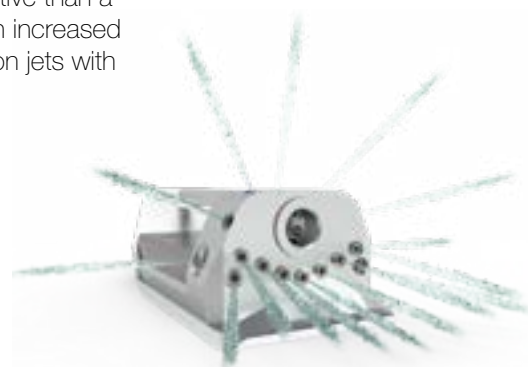

Plus

	3/4"	1"	1"	1" 1/4
LxWxH	355x160x120 mm			
	17 kg	17 kg	22 kg	22 kg
	11 x 0° / 5° / 10° / 15° / 25° / 90°			
	5 x 75° (PLUS)			
	85510.Wxx			
	400-1500 mm			
#Basic	65500.872W	65500.87W	65500.870W	65500.871W
#Plus	65500.872RW	65500.87RW	65500.870RW	65500.871RW

NATISONE

Self-balancing heavy torpedo nozzles



	3/4" F	1" F	1" F	1" 1/4 F
DxL	100 x 260 mm	140 x 400 mm	160 x 520 mm	
	10 kg	18 kg	32 kg	
	5 x 15°	7 x 15° / 25°	9 x 10° / 15° / 20° / 25° / 30°	
	85510.Wxx		85510.Wxx	
	150-600 mm	250-1200 mm	250-1500 mm	
#	65500.800W	65500.810W	65500.820W	65500.840W

RAVEDIS

TREMOL

ROTATING AND VIBRATING ACTION

FOR THE REMOVAL OF RESISTANT OBSTRUCTIONS OR LIMESTONE SEDIMENTS

TREMOL

Rotating nozzles with radial jets

AVIAN TURBINE

Rotating head turbine nozzles with carbide teeth, for limestone and calcified obstructions

GRIS

Rotating nozzles with carbide tooth for limestone removal

RAVEDIS

Vibrating nozzles with eccentric rotor for descaling and limestone removal







MALNIS

Vibrating nozzles with eccentric rotor for PVC pipes

TREMOL

Rotating nozzles with radial jets







	3/4" F	1" F	1" 1/4 F
 DxL	50 x 99 mm	70 x 125 mm	70 x 125 mm
 KG	0,84 kg	2,3 kg	2,3 kg
	6 x 20°	6 x 20°	6 x 20°
	2 x 90° + 2 x 85°	2 x 90° + 2 x 85°	2 x 90° + 2 x 85°
	85511.xx	85511.xx	85511.xx
	100-200 mm	100-300 mm	100-300 mm
	75510.350R	75510.250R	75510.27R

AVIAN TURBINE

Stainless steel turbine driven nozzles with carbide cutting head







	1/2" F	3/4" F	1" F
DxL	36 x 60 mm	55 x 83 mm	70 x 140 mm
 KG	0,3 kg	1 kg	2,6 kg
	3 x 90°	3 x 90°	3 x 90°
	6 x 25°	4 x 20°	6 x 20°
	85990.xx	85993.xx (rotation) 85511.xx (thrust)	85993.xx (rotation) 85511.xx (thrust)
	>50 mm	>80 mm	>125 mm
#	75510.17TTW	75510.360TTW	75510.260TTW

GRIS

Rotating nozzles with carbide tooth for limestone removal



	1/8" F	1/4" F	3/8" F	1/2" F
DxL	19 x 28 mm	23 x 35 mm	30 x 62 mm	35 x 62 mm
 KG	30 gr	100 gr	325 gr	325 gr
	3 x 25°	3 x 25°	3 x 25°	6 x 25°
	2 x 90° + 2 x 45°	2 x 90° + 2 x 35°	2 x 90° + 2 x 45°	2 x 90° + 2 x 45°
	40-90 mm	40-100 mm	> 50 mm	> 50 mm
#	75510.190D	75510.230D	75510.120D	75510.140D





MALNIS

Stainless steel spinning nozzles with off-axis rotor for vibrating/hammering action.

Thanks to the round head it offers a light vibration and therefore recommended for PVC pipes

LIGHT VIBRATING NOZZLES



	3/8" F	1/2" F
DxL	35 x 63 mm	35 x 63 mm
 kg	350 gr	350 gr
	3 x 25°	3 x 25°
	1 x 90°	1 x 90°
	85990.xx	85990.xx
	80-175 mm	80-175 mm
#	77399.100	77399.250

RAVEDIS

Stainless steel spinning nozzles with off-axis rotor for vibrating/hammering action.





Crowned head nozzles are more aggressive and effective in descaling and limestone removal

ATTENTION! Never use these nozzles in gres, ceramic or thin PVC pipes



HEAVY VIBRATING NOZZLES



	1/4" F	1/2" F	3/4" F	1" F
DxL	30 x 60 mm	48 x 95 mm	58 x 110 mm	78 x 126 mm
 kg	0,24 kg	0,81 kg	1,4 kg	3 kg
	3 x 25°	6 x 10°	6 x 10°	5 x 25°
	1 x 90°	1 x 90°	1 x 90°	1 x 90°
	85990.xx	85993.xx	85993.xx	85511.xx
	50-125 mm	100-225 mm	125-300 mm	125-300 mm
#	77400.050	77400.250	77400.650	77400.750



ROOT-CUTTERS

CARNIA

SOLO

Rotating nozzles with chains roots, rust, limestone and unsuccessful liners removal.

The factors to consider when choosing the tool are:

- dimensions of the pipeline
- typology of the obstruction to be removed
- characteristics of the high pressure pump and water delivery pipe size

In the following table you can find the different types of root-cutters compatible with different working diameters.

Chain nozzles should always be used with chains and centralizer suitable for the pipe diameter.

AVIAN

Multifunctional nozzle with interchangeable rotating head. Can be converted into a milling cutter by replacing the head

SOLO

With circular chains equipped with carbide plates to clean and scarify in an innovative and extremely effective way

CARNIA AND FRIULI

Nozzles with ring chains with interchangeable heads for use in DN 100-350 (Carnia) and DN 200-500 (Friuli)

MANIAGO

It can be used with different types of chains (rings, motor or double-blade chains) in pipelines DN 200-600

ROOT RANGER

It is an extremely efficient nozzle for precise backward removal of roots, grease and debris from DN100-150 pipelines.

It can be used in combination with professional pressure washers, compact high pressure cleaners

Nozzle	Hose fitting	Working DN (mm)												
		50	80	100	125	150	200	300	400	500	600			
AVIAN	1/2"	■												
	3/4"		■											
	1"			■										
SOLO	1/2"		■											
	3/4"			■										
	1"				■									
ROOT RANGER	1/4" - 3/8"			■										
CARNIA	3/4"			■										
FRIULI	1"						■							
MANIAGO	1"							■						

AVIAN

Stainless steel root cutter spinning nozzle package with sprocket chains. Package includes: nozzle with chain supporting head; chain set (100/125/150/200); 150 - 200 centralizer; tools and plastic case; hose connection can be adapted to 1/2", 3/4" or 1" HP hose.

APPLICATION

Removal of roots, rust, unsuccessful liners or point repairs. Nozzle with round head can be used for pipe cleaning.



	1/2" F	3/4" F	1" F
DxL	36 x 60 mm	55 x 83 mm	70 x 140 mm
KG	0,3 kg	1 kg	2.6 kg
∠	3 x 90°	3 x 90°	3 x 90°
V	6 x 25°	4 x 20°	6 x 20°
85990.xx	85993.xx	85511.xx	
∅	50-100 mm	80-150 mm	100-200
#Kit	VALK1A1.01	VALK3A1.01	VALK6A1.01

SOLO

Stainless steel spinning or turbine driven nozzle package with plastic case including circular chains for root cutting applications

	1/2" F	3/4" F	1" F
DxL	36 x 60 mm	55 x 83 mm	70 x 140 mm
KG	0,3 kg	1,0 kg	2,6 kg
∅	70-100 mm	100-150 mm	150-300 mm
#1	VALK1A2.01	VALK3A2.01	VALK6A2.01
#2	VALK1A2T.01	VALK3A2T.01	VALK6A2T.01

#1 = Kit Solo

#2 = Kit Solo Turbine = increased rotational force and water saving

CARNIA - FRIULI - MANIAGO

Stainless steel spinning nozzles with ring chains, interchangeable head and ceramic inserts



	Carnia ¾"	Friuli 1"	Maniago 1"
DxL	60 x 150 mm	74 x 170 mm	120 x 130 mm
KG	1,5 kg	2,9 kg	3,3 kg
Scissors	6 x 90°	6 x 90°	3 x 90°
Wrench	6 x 20°	6 x 20°	3 x 20°
Drill bit	85993.xx (rotation) 85511.xx (thrust)	85993.xx (rotation) 85511.xx (thrust)	85511.xx
Drill diameter	100-350 mm	200-500 mm	225-575 mm
#Kit	VALK3C.01	VALK6C.01	K25.RC01

RECOMMENDED GUIDE:



Ugello Carnia montato su Guida di centraggio DN 150-300 (cod. 5023.02)



Ugello Maniago montato su Guida di centraggio DN200-450 (cod. 5023.01-1)

ROOT RANGER

Root cutter nozzle with high speed rotating jet for rearward debris removal

The Root Ranger nozzle in 1/4" or 3/8" is the optimum solution for removing roots, grease and debris from domestic pipes up to DN 150 mm.

It is a one-piece nozzle that can be assembled on site in 1 minute without the need of additional tools.

It has an optional inclined front jet for better penetration (this reduces the thrust by 15%). Extremely effective, it is sold worldwide to plumbers who need effective pipe cleaning on the first try.

Beware of cheap copies. The original Root Ranger nozzle is manufactured by Mustang Nozzles Australia. It is made of high strengthened stainless steel and will last for many years.



Part No.	Description
77532.01	Root Ranger 1/4" F root cutting nozzle with high-speed rotating rear jet
77532.02	Root Ranger 3/8" F root cutting nozzle with high-speed rotating rear jet
77532.00L	Root Ranger 1/2" F root cutting nozzle with high-speed rotating rear jet

AVIAN AND SOLO SPARE PARTS

PARTS AND COMPONENTS

(nozzle + head + accessories)



Chain supporting head and chains



Carbide cutting head



Solo exploded view

NOZZLES

Spinning nozzle
(without inserts)

Insert configuration

Turbine nozzle
(without inserts)

Insert configuration

HEADS

Chain supporting head
w/chains

Carbide cutting head

SOLO head

CHAINS

Sprocket chain set

DN 70 SOLO chain

DN 100 SOLO chain

DN 150 SOLO chain

DN 200 SOLO chain

DN 225 SOLO chain

CENTRALIZERS

DN70 ring centralizer

DN100 ring centralizer

DN125 ring centralizer

DN150 ring centralizer

DN150÷200 centralizer

DN150÷300 centralizer

DN200÷450 centralizer

Case with keys

	1/2" F	VALK1A2.01	VALK1A2T.01	VALK1A1.01	3/4" F	VALK3A2.01	VALK3A2T.01	VALK3A1.01	1" F	VALK6A2.01	VALK6A2T.01	VALK6A1.01
Spinning nozzle (without inserts)	75510.17R	•	•		75510.360R	•	•		75510.260R	•	•	
Insert configuration	TA.75510.17R	•			TA.75510.360R	•	•		TA.75510.260R	•	•	
Turbine nozzle (without inserts)	75510.17T		•		75510.360T		•		75510.260T		•	
Insert configuration	TA.75510.17T		•		TA.75510.360T		•		TA.75510.260T		•	
Chain supporting head w/chains	75527.25C1	○	○	•	75527.27C1	○	○	•	75527.30C	○	○	•
Carbide cutting head	75527.25B	○	○	○	75527.27B	○	○	○	75527.30B	○	○	○
SOLO head	75527.25D	•	•	○	75527.27D	•	•	○	75527.30D	•	•	○
Sprocket chain set	75001.10A-K1	○	○	•	75001.11-K1	○	○	•	75001.15-K1	○	○	•
DN 70 SOLO chain	50.CC070-8	•	•	○								
DN 100 SOLO chain	50.CC100-8	•	•	○	50.CC100-12	•	•	○				
DN 150 SOLO chain					50.CC150-12	•	•	○	50.CC150-12	•	•	○
DN 200 SOLO chain									50.CC200-12	•	•	○
DN 225 SOLO chain									50.CC225-12	○	○	○
DN70 ring centralizer	5305.12A	•	•	•								
DN100 ring centralizer	5305.12B	•	•	•	5305.34B	•	•	○				
DN125 ring centralizer					5305.34A	○	○	•				
DN150 ring centralizer					5305.34C	•	•	○				
DN150÷200 centralizer									5305.10	•	•	•
DN150÷300 centralizer					5023.02	○	○	○				
DN200÷450 centralizer									5023.01-1	○	○	○
Case with keys		•	•	•		•	•	•		•	•	•



SOLO chain



Centralizer rings for Avian and SOLO nozzles

CLEANING DOMESTIC DRAINS (DN30-200)

The nozzles in this category satisfy the most ordinary cleaning needs in domestic and condominium pipelines, combining materials (stainless steel and not), weight, small dimensions and thrust jet inclinations.

Normally these nozzles have 1/8", 1/4", 3/8", and 1/2" female threads but they are also available with M threads.

SILE

Conical and round head nozzles with different configurations of front jets to break through the difficult obstructions

PICIUL

Compact, high thrust, stainless steel nozzles

MEDUNA

1/2" round head nozzles, short and with high traction; ideal for overcoming vertical columns and multiple 90° bends

RAUT

Small nozzles with triangular front jets for breaking through obstructions

CELLINA

Standard nozzles with 35° jets

VORTEX

Round head nozzles with combined tilting jet (15°/35°), ideal for removing limestone from vertical columns

PIAVE

Flat nozzle with 1/2" F hose fitting and ceramic inserts, for use in square or rectangular pipes

LIVENZA

Conical head nozzles with interchangeable inserts

ARZINO

Egg nozzles with interchangeable inserts (steel or ceramic), with 15° jets to give the nozzle thrust and traction

TREMOL

Small nozzles with rotating radial jets

GRIS

Small nozzles with rotating radial jets and with tooth

BORA

Stainless steel nozzles with high impact rotating front jet

CANIN

Very high traction torpedo nozzles with 5°/10° jets

ISONZO

Stainless steel nozzles with 30° washing jets

SUITABLE FOR:



Water jetting machines



High-pressure built-in sewer cleaning units



Vehicles equipped for water jetting

1/8"



	Sile			Piciul		Tremol	Gris
DxL	15 x 15 mm	15 x 15 mm	15 x 15 mm	13,5 x 17 mm	13,5 x 17 mm	16 x 28 mm	19 x 28 mm
KG	8 gr	8 gr	8 gr	8 gr	8 gr	30	30
Y	35°	35°	35°	25°	25°	25°	25°
Z	-	2 x 0° / 15°	1 + 3 x 0° / 15°	-	0°	-	-
Q	-	-	-	-	-	90° / 25°	90° / 45°
R	> 20 mm	> 20 mm	> 20 mm	> 20 mm	> 20 mm	> 30 mm	> 30 mm
#	5500.07	5500.07F2	5500.07TR	3520.S10	3520.S10A	75510.190R	75510.190D

1/4"



	Sile			Piciul	Raut	Tremol	Gris	Arzino
DxL	18 x 29 mm	18 x 29 mm	18 x 29 mm	18 x 21 mm	19 x 31 mm	20 x 35 mm	23 x 35 mm	25 x 30 mm
KG	25 gr	25 gr	25 gr	18 gr	32 gr	100 gr	100 gr	54 gr
Y	35°	35°	-	25°	25°	25°	25°	15°
Z	0°	0° / 15°	2 x 0° / 15°	0°	3 + 1 x 20° / 0°	No	No	0°
Q	-	-	-	-	-	90° / 85°	90° / 35°	90° / 85°
R	> 25 mm	> 25 mm	> 25 mm	> 30 mm	> 30 mm	> 30 mm	> 30 mm	> 40 mm
#	3518.00	3518.00TR	3518.00A	3520.S13	5560.05	75510.230R	75510.230D	5526.00

3/8"



	Sile			Piciul	Raut	Tremol	Gris	Arzino	Isonzo
DxL	23 x 31 mm	23 x 31 mm	23 x 31 mm	25 x 24 mm	25 x 40 mm	30 x 62 mm	30 x 62 mm	30 x 37 mm	39 x 60 mm
KG	40 gr	40 gr	40 gr	80 gr	80 gr	325 gr	325 gr	100 gr	370 gr
Y	35°	35°	-	25°	20°	25°	25°	15°	30°
Z	0°	0° / 15°	1 + 6 x 0°/15°	0°	3+ 1 x 15°/0°	-	-	0°	0°
Q	-	-	-	-	-	90° / 85°	90° / 25°	-	-
R	> 20 mm	> 20 mm	> 20 mm	> 40 mm	> 40 mm	> 50 mm	> 50 mm	> 50 mm	> 60 mm
#	3519.00	3519.00TR	3519.00A	3520.S19	5560.08	75510.120R	75510.120D	5527.00	65540.090

1/2" M



	Cellina	Meduna	Arzino	Raut	Tremol
DxL	25 x 50 mm	25 x 43 mm	31 x 48 mm	30 x 59 mm	35 x 62 mm
KG	120 gr	70 gr	130 gr	145 gr	325 gr
Y	35°	25°	35°	6 x 25°	25°
Z	0°	-	0°	3 x 25° + 1 x 0°	-
W	-	-	-	-	90° / 85°
Ø	> 50 mm	> 50 mm	> 40 mm	> 70 mm	> 50 mm
#	5520.20	3520.110	5529.06	5550.10M	75510.14M

1/2" F



	Cellina	Piciul	Meduna	Vortex	Raut	Tremol	Gris
DxL	28 x 46 mm	30 x 27 mm	25 x 36 mm	37 x 37 mm	32 x 55 mm	35 x 62 mm	35 x 62 mm
KG	95 gr	66 gr	65 gr	175 gr	160 gr	325 gr	325 gr
Y	35°	30°	25°	15° / 35°	6 x 20°	25°	25°
Z	0°	0°	0°	0°	3 x 20° + 1 x 0°	-	-
W	-	-	-	-	-	90° / 85°	90° / 25°
Ø	> 50 mm	> 50 mm	> 50 mm	> 70 mm	50 - 250 mm	> 50 mm	> 50 mm
#	5520.30	3520.S21	3520.210	5528.50	5550.10	75510.14R	75510.140D



	Arzino	Isonzo	Canin	Bora	Piave
DxL	48 x 60 mm	49 x 80 mm	49 x 75 mm	39 x 61 mm	165 x 94 x 37 mm
KG	330 gr	800 gr	800 gr	400 gr	3500 gr
Y	6 x 15°	6 x 30°	6 x 10°	6 x 20°	4 x 5° / 10°
Z	0°	0°	0°	18° rotante	0°
Ø	> 80 mm	> 80 mm	> 50 mm	> 40 mm	> 150 mm
#	5528.06	65540.100	65540.765	75150.01	65500.880

CENTRALIZERS

For root cutters and rotating nozzles

DN 150-300 centralizer

with a set of adjustable position skids.
Suitable for 3/4" nozzles (Tremol, Avian, Carnia)

	3/4" F/M
DN	150-300 mm
Weight	3,4 kg
Lenght	250 mm
Max pressure	300 bar
#	5023.02



DN 200-450 centralizer

with 2 sets of adjustable position skids.
Steel wheels are set on bigger skids. Suitable for 1" nozzles (Tremol, Maniago)

	1" F/M
DN	200-450 mm
Weight	7,5 kg
Lenght	325 mm
Max pressure	300 bar
#	5023.01-1



DN 225-600 centralizer with pantograph opening, and rubber wheels. Adjustable ring can be fixed along marked positions in order to open the centralizer at required DN. Suitable for 1" nozzles (Maniago)

	1" F/M
DN	225-600 mm
Weight	9,3 kg
Lenght	600 mm
Max pressure	300 bar
#	5025.01



VENTURI PUMP

The Venturi devices allow the operator to suck liquid or solid materials thanks to the Venturi-effect generated by the speed of water jets within the cone. The fluid goes through a restriction and creates the vacuum

APPLICATION

This device can be used:

1. as a pump supplied by high pressure water to empty tanks, pools or flooded basements.
#5100.00 does not require high flow pumps and is compatible with portable water jetters
2. in order to help suction pump for increasing speed and depth.
For this application, it can be used with water or air, depending on the density of the sludge to be sucked

Suction hose has to be connected to the outlet in order to discharge sludge. Suction capacity depends on flow and depth (see chart). Inserts size has to be selected on the base of pump parameter (flow and pressure). Couplings for suction hose are not included (to be ordered separately). Double threaded versions are available upon request for steel suction hoses



	DN40	DN80	DN100
Inlet (air/water)	3/8" F	1/2" F	1/2" F
Suction DN	DN40	DN80	DN100
Length (mm)	115	270	370
Weight (kg)	0,33	4,7	5,7
Maximum pressure (bar)	250	225	225
#	5100.00	5100.10	5100.12
intermediate d.		5110.01	5110.02

The DN40 device is provided with 5 mt of suction hose DN40 mm.



DN40 device with 5 mt of suction hoses (DN40)



Double threaded intermediate device

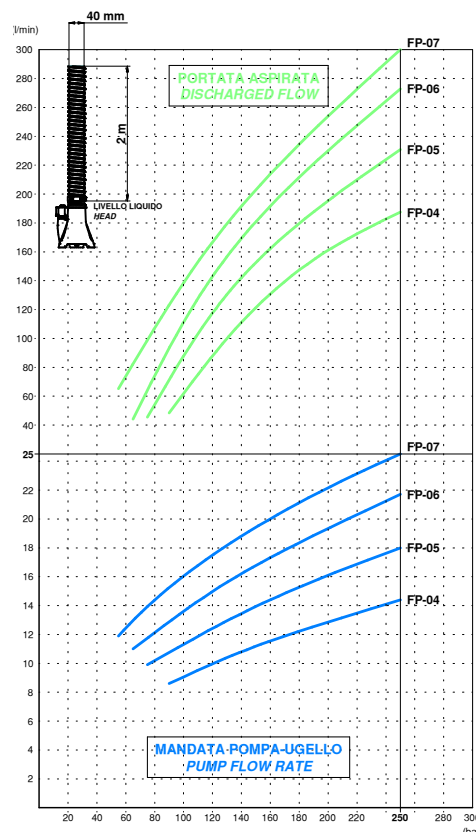

DN40 device:

discharged flow and pressure according to the pump flow and size of nozzle (FP).

MEDUSA



Medusa is a flushing device to be fixed on the steel suction pipe. At the same time it cleans bottom and walls of the manhole and sucks sediments. It can also be used for hydro excavation applications.

Inlet: 1/2" M or F available on request.



Part No.	Suction hose DN (mm)	Pipe OD range (mm)	Weight (kg)
000D.080	80 mm / 3"	75 - 84	3,0
000D.100	100 mm / 4 "	95 - 104	3,3
000D.120	120 mm / 5"	115 - 125	3,8
000D.150	150 mm / 6"	145 - 154	3,9
000D.200	200 mm / 8"	195 - 204	5,5

SAVE HOSE DEVICES

Save hose devices protect the integrity of high pressure hoses reducing friction with sharp edges.

A regular and proper use reduces the risk of pipe bursting, increases safety for the operators and the equipment around the job site.

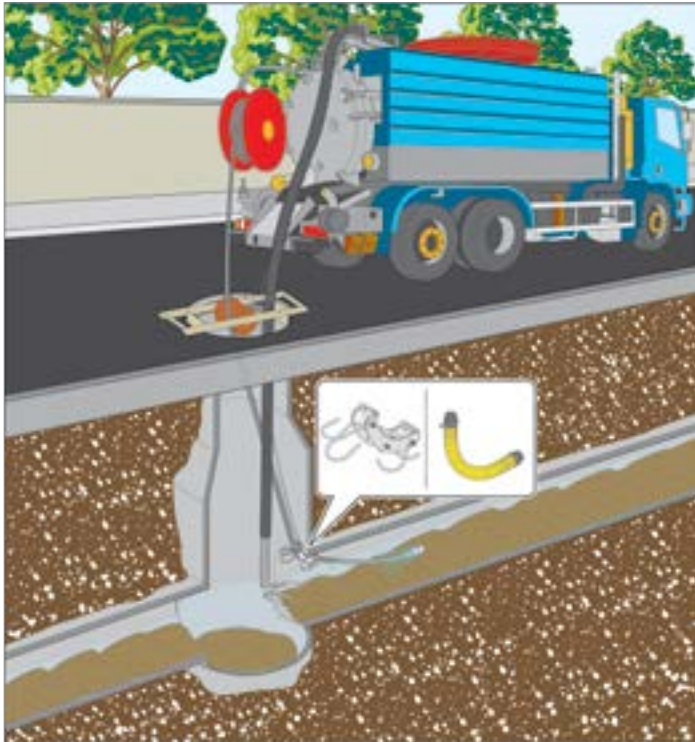

LOWER GUIDE

Lower guide "banana" style (**5900.07**) is used in the lower part of the manhole, at the start of the pipeline, positioned on the top edge of the pipe

It can be used in the lower part of the manhole, at the start of the pipeline.

Robust and resistant, they are equipped with teflon wheels that make the scrolling of the hose easier.

The open arches guide (**5900.05A** and **5900.01**) can be used also when the cleaning operation has already started, with the pipe and the nozzle already inside the pipeline.

The smallest lower guide (**5900.01**) can be used also to protect cctv cable.

5 meters of rope are provided for each guide.

ATTENTION!

Field tests have shown that using upper and lower guide **reduces friction by 50%!**



5900.01 Stainless steel save hose device for 3/8" - 1/2" hoses.

Length: 300 mm | Weight: 2,5 kg

5900.011 Spare roller for 5900.01

5900.05A Save hose device in SS with open arches for 3/4" and 1" hoses.

Length.: 580 mm | Weight 4,1 kg

5900.051 Spare roller for 5900.05A

5900.07 Galvanized steel save hose device for 1" - 1 1/4 hoses

Length.: 590 mm | Weight 8,6 kg

5900.071 Spare roller for 5900.07



MANHOLE UPPER GUIDE

The roller guide is needed when the reel of the sewer cleaning vehicle is not placed over the manhole.

Made of galvanized steel with red plastic wheel.

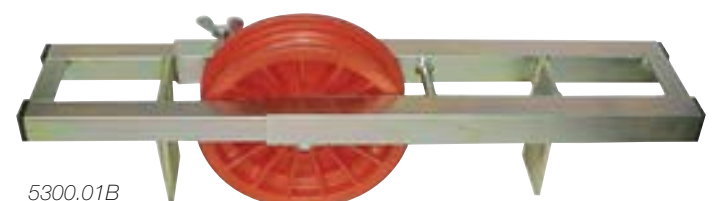

5300.01B

5300.01B Upper save-hose guide

5300.201 Spare roller for 5300.01B

TIGER TAIL

This 90 cm long flexible guide can be used either in the lower or upper part of the manhole. Available in different sizes (DN50/80/100) and materials (smooth or rugged PVC) to better adapt to the size and type of HP hose. They can also be used to protect CCTV camera cables. 5 meters of rope are provided for each guide.

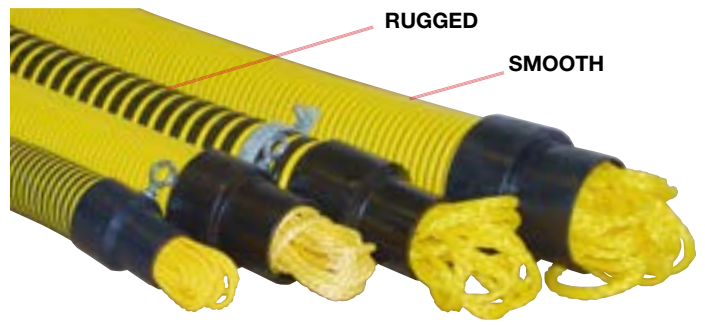

Tiger Tail Guides

5900.10	Tiger tail 2"/DN50 for 1/2" and 3/4" hoses
5900.15	Tiger tail 3"/DN80 for 3/4" and 1" hoses
5900.20	Tiger tail 3"/DN80 (rugged)
5900.25	Tiger tail 4"/DN100 for hoses up to 1 1/4"

MANHOLE COVER LIFTERS

MAGNETIC KEY MR. OLIMPIA

With rubber handles, knuckle joint and 240 cm² surface area magnet for exceptional magnetic power even on covers with very structured or dirty surface.

MAGNETIC KEY

With hook and hammer, this tool makes lifting manhole covers easier than ever.

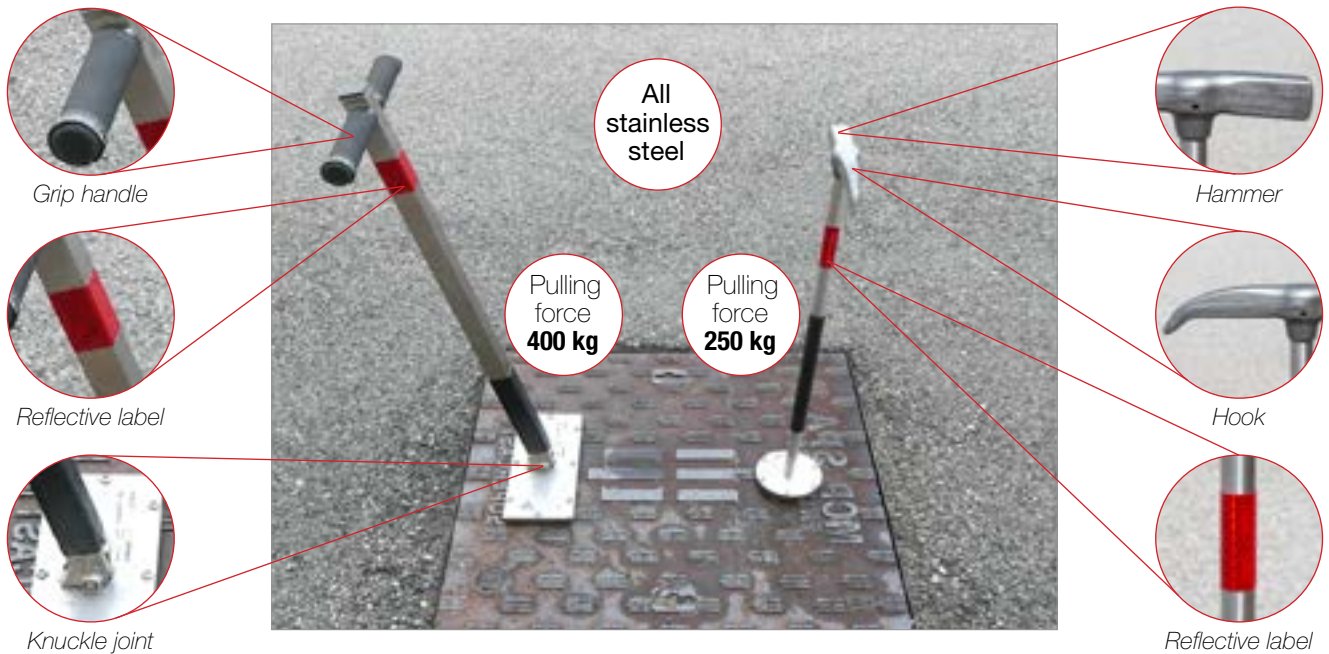

5400.25-03 Manhole Key MR. OLIMPIA (400 kg)

5400.25-02S Manhole Key SUPER STRONG (250 kg)

TITAN-ALU

Lever and set of hooks to adapt to any type of cover.



MANHOLE COVER LIFTER WITH HOOK

Made in tempered steel.

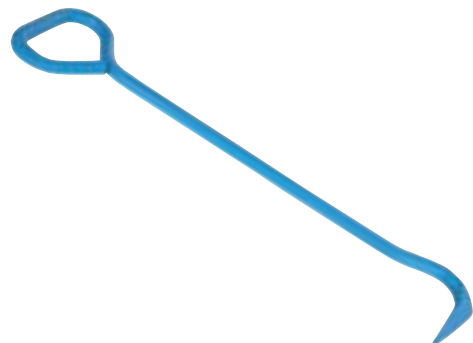

5400.04T1 Manhole cover lifter Titan-Alu

5400.00 3 Hooks Kit for Titan-Alu

5400.24 Manhole cover lifter

WE JET THE WORLD



NUOVA CONTEC SRL

Zona Industriale 2/1
33086 Montereale V. (PN), Italy

Tel.: +39 0427 799505
Fax: +39 0427 799381

mail: info@nuovacontec.com
web: www.nuovacontec.com